

ShinMaywa

Helical Rotor Blower

(Roots Type)

ARH-S/SP ARH-E/EP Series

ARH-S/SP Series

With IE1/IE2 Motor

ARH-E/EP Series

With Premium Efficiency IE3 Motor

Full lineup of helical blowers for a variety of applications

ShinMaywa helical blowers are the latest in roots-type blowers which incorporate low noise technology.

We use our outstanding technology to meet the high-level needs of the world of industry by also giving consideration to environmental problems such as noise.

Comprehensive low-noise design

The design suppresses vibration in the low-frequency range where blower noise is generated.



The reason why ShinMaywa blower noise suppression is successful is as follows. The main sources of blower noise include sources such as "**pulsating noise of rotor**", followed by "**gear meshing**", and then "**bearings**". Of particular note is the pulsating noise (roots noise) generated by the air which is displaced by the rotors. At ShinMaywa we have successfully used "**3-lobe helical rotor**" to greatly reduce the amount of this pulsating noise. Furthermore, ShinMaywa technology for suppressing sound is not limited to just the rotors. We have also devised a torsional shape for the teeth gears which drive the rotors.

Q What is the difference between helical-type rotors and spur-type rotors?

A ShinMaywa helical rotors have three lobes twisted in a spiral shape, so that they displace the air continuously to prevent pulsating noise from occurring.

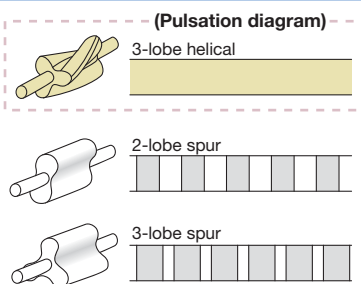

Q Because there is only a small gap between the twisted rotors and the rotor housing, is high-precision machining required?

A A high-precision machine called a "milling machine" is used for machining the screws and the gears, so that the rotors are manufactured with high precision and high reliability.



● Rotor processing using a milling machine

[Processing method]

The rotor turns slowly to match the rotation of the cutter. The cutter moves forward in the direction of the arrow while rotating.

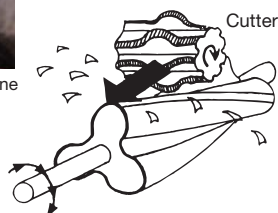

Q When the rotors are twisted, does the amount of blown air drop for each rotation?

A The tips of the rotor teeth used by ShinMaywa are slim. Therefore, even though the rotors are twisted, the amount of air blown per rotation is more than spur type blowers.

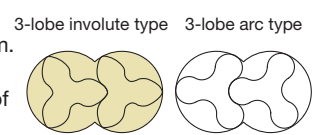

Q How do you inspect the twisting of the precision rotors and the curve of the teeth?

A The shape of the rotor teeth is inspected using 3-dimensional measuring equipment. Measurement results are output to a plotter. Thorough quality control is carried out to ensure that the curvature of the teeth is within the allowable tolerances.



Results are output

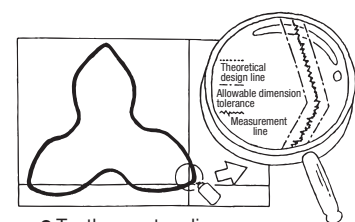



Data showing the low-noise operation of ShinMaywa helical blowers

For low-frequency noise which is expensive to reduce, our design reduces the noise inside machine chambers by 2dB and outside the machine chambers by about 8 dB compared to spur-type blowers.

A difference of 3dB doubles the perceived noise!
A difference of 8dB increases the perceived noise by about 7 times.

Comparison of noise frequencies between ShinMaywa helical blowers and general spur-type blowers

Blower noise consists of low-frequency range noise and high-frequency range noise.

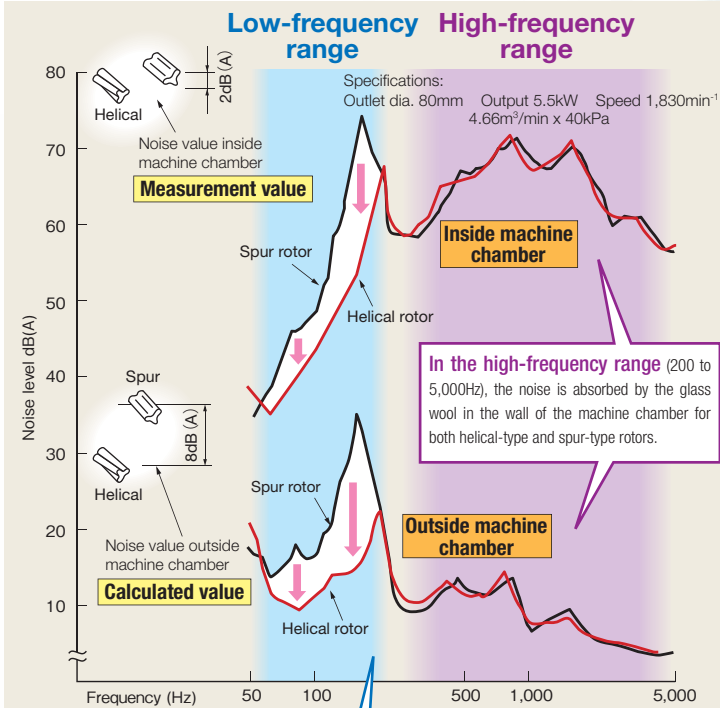

In the low-frequency range (50 to 160Hz), it can be seen that the noise volume is higher for spur-type rotors than for helical-type rotors. This is because noise in the low-frequency range is not absorbed by the glass wool and leaks outside the machine chamber. The low-noise design of ShinMaywa helical blowers significantly reduce the amount of noise output in the low-frequency band, which is the main cause of noise. This technological ability provides a large difference in the amount of noise in the low-frequency range.

When installed near the workplace or in apartment blocks, it can greatly reduce the costs of noise-reduction measures.

Reliable oil seal

Fluororubber is used for the oil seal. The lubricating system is protected with the labyrinth seal which is effective to prevent oil leakage.

Easy maintenance

The bearing is fixed with a C-type retaining ring. The timing gear can be disassembled easily by a gear puller. A ball bearing is employed instead of a roller bearing, to avoid damaging the inner case during reassembly. Thus, the blower maintenance has been significantly simplified.

Improved durability

The blower durability has been improved through the use of a larger bearing and the lowering of motor speed, as well as the reduction of temperature rise.

Variable Frequency Driver (VFD) controlled air flow rate

VFD control system permits the motor speed to be easily changed electrically. When VFD control is used with the blower, the air flow rate can be varied freely. Also, by using a suitable control device with the blower, it is possible to implement automatic control of the blower. (The controllable range of motor speed depends upon blower working conditions. When using a VFD with the blower, consult your nearest dealer.)

※The VFD to be used should be a constant torque type.

Performance Curve ARH-S

ARH20S

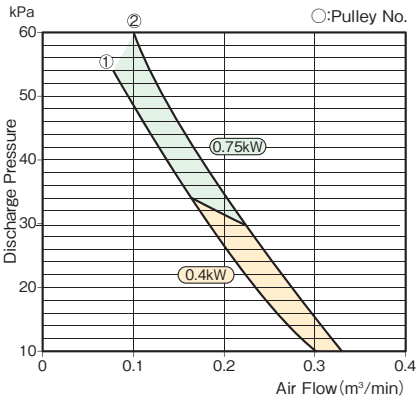

ARH25S

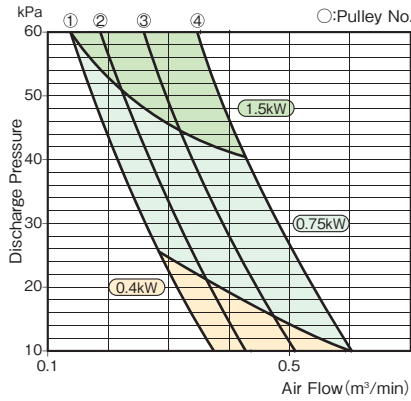

ARH32S

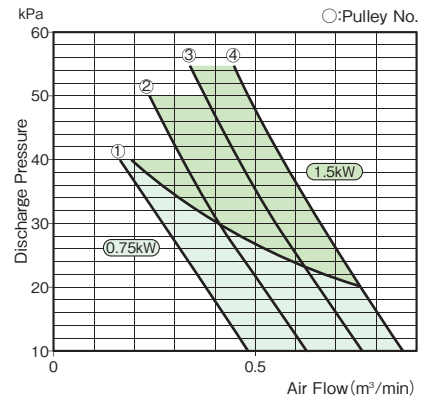

ARH40S

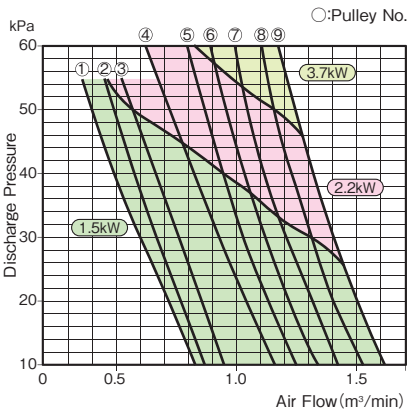

ARH50S

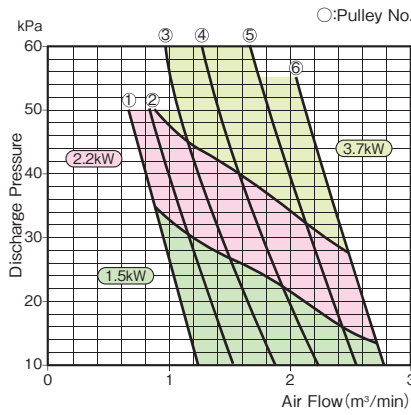

ARH65S

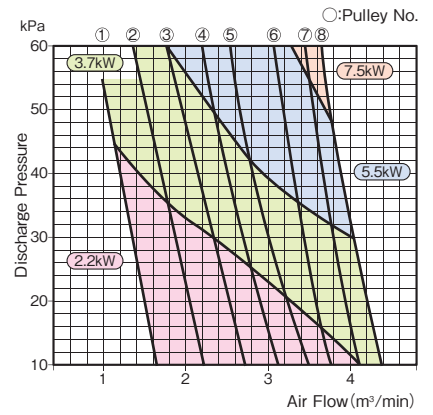

ARH80S

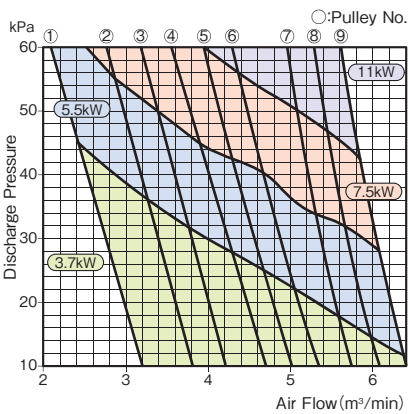

ARH100S

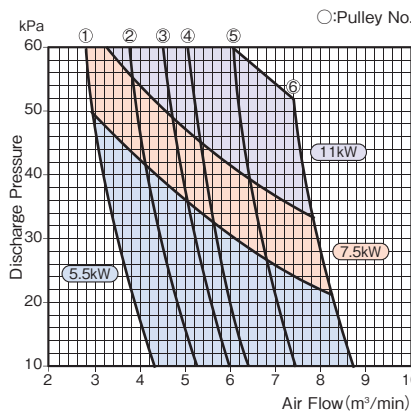

ARH125S

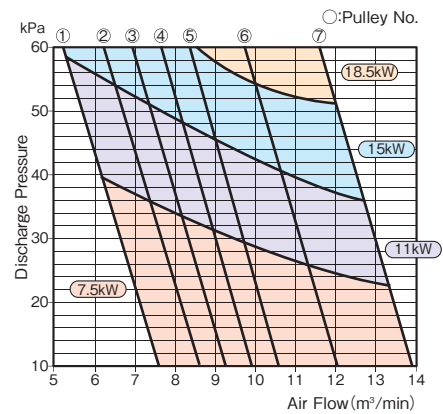

ARH125SA

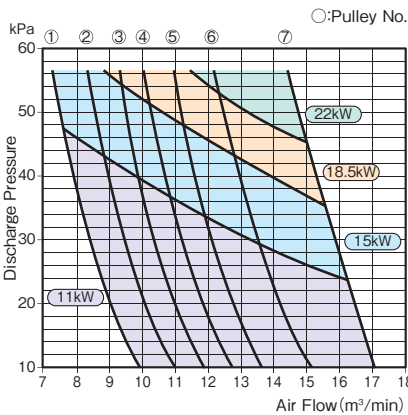

ARH125SF

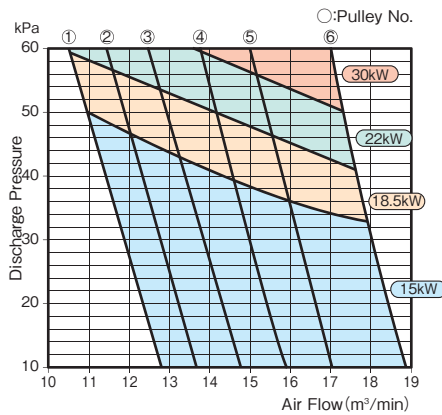

ARH150S

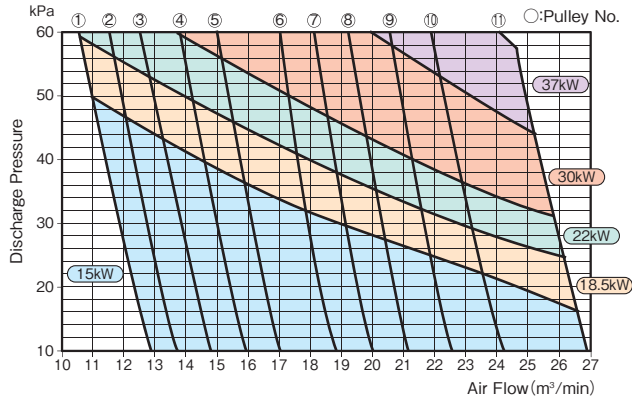

ARH200S

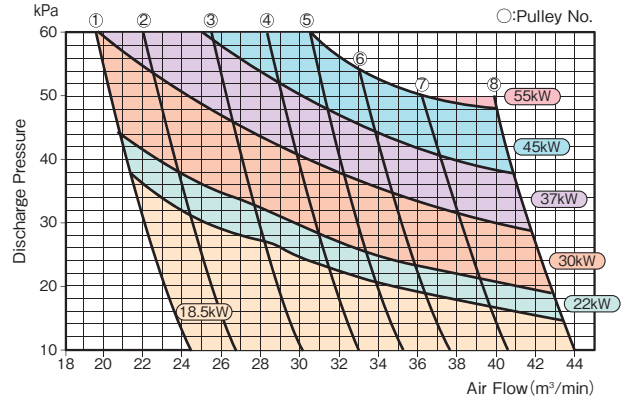

Performance Curve ARH-SP

ARH50SP

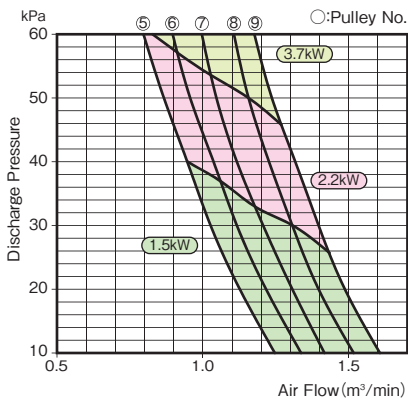

ARH65SP

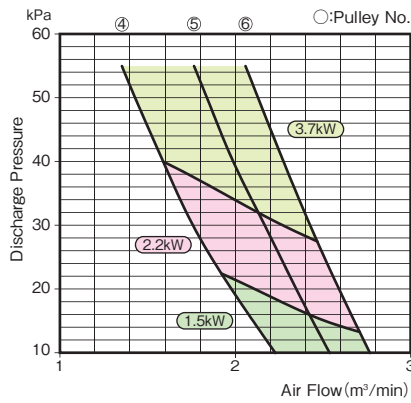

ARH80SP

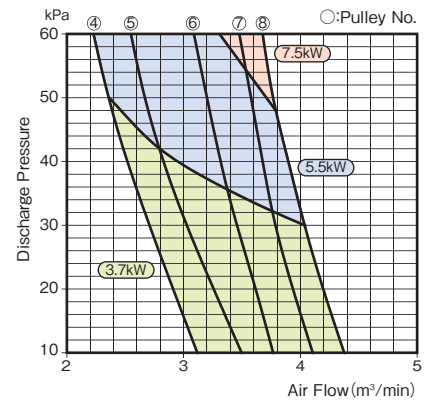

ARH100SP

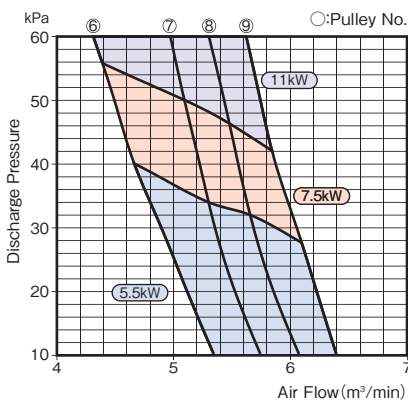

Notes:

- (1) The air flow rate indicates the volume of air on the suction side.
- (2) Air flow rate tolerance: $\pm 5\%$
- (3) Consult us for any requirements not included in the table.
- (4) For indoor use only. Consult us for outdoor applications.
- (5) Specifications are subject to change without notice.
- (6) Please prepare IE1 / IE2 motor by yourself.
Since ShinMaywa cannot supply IE1 / IE2 motor due to Japanese regulation.

Dimensions

(mm)

Standard Dimensions

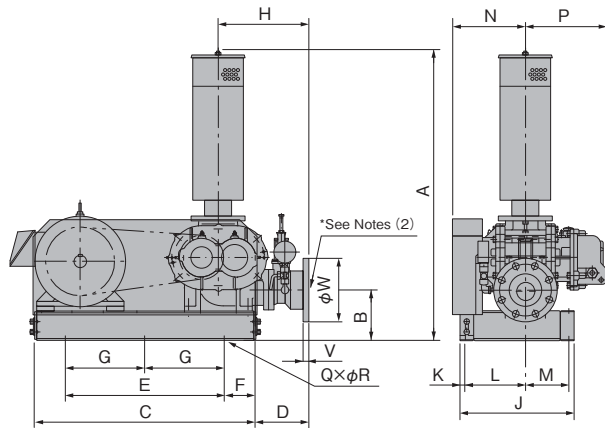

Dimensions with anti-vibration base

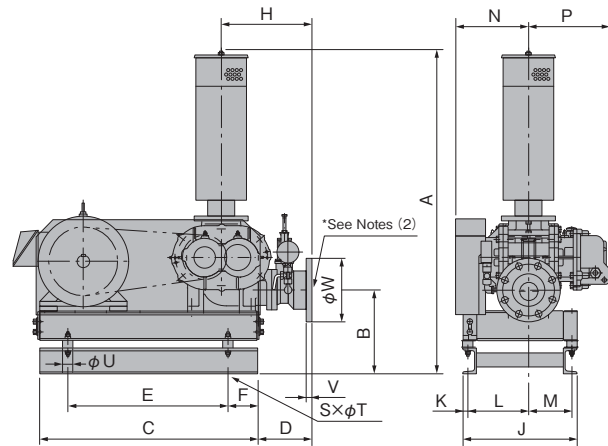

Model	Outlet dia (mm)	A	B	C	D	E	F	G	H	J	K	L	M	N	P	Q	R	S	T	U	V	W	Weight (kg)
ARH20S	20	456 (511)	133 (188)	430	53 (25)	350	25	—	256 (228)	300	13	110	164	124	156	4	12	—	12	20	—	—	22 (26)
ARH25S	25	741 (841)	135 (235)	487 (479)	125 (129)	340	74 (70)	—	215	290	15	130	130	173	221								13
ARH32S	32	809 (909)	137 (237)	556 (548)	120 (124)	400	78 (74)	—	207	330		15	175	125	202	228	13	4	13	25	20	—	
ARH40S	40	948 (1,047)	147 (246)	636 (628)	138 (142)	460	88 (84)	—	245		440		15	174	126	212							234
ARH50S	50	1,009 (1,108)	155 (254)	704 (696)	164 (168)	540	82 (78)	—	294	470		15		172	158	209	247	13	4	13	22	—	—
ARH65S	65	995 (1,094)	143 (242)	722 (714)	151 (155)		540	91 (87)	270 (—)		281		520	15	165	245	219						
ARH80S	3.7~7.5kW	1,098 (1,197)	150 (249)	788 (780)	266 (270)	540		82 (78)	—	294	470	15			221	189	288	289	13	4	13	22	—
	11kW	1,323 (1,422)	193 (292)	788	260		540	91 (87)	270 (—)	281			520	15	221	189	288	289					
ARH100S	100	1,297 (1,396)	193 (292)	788	260	540		91 (87)	270 (—)	281	520	15			221	189	288	289	13	4	13	22	—
ARH125S	125	1,323 (1,422)	193 (292)	788	260		540	91 (87)	270 (—)	281			520	15	221	189	288	289					
ARH125SA	125	1,695 (1,793)	205 (303)	980 (976)	238 (240)	540		82 (78)	—	294	570	15			234	196	372	395	13	4	13	22	—
ARH125SF	125	1,323 (1,422)	193 (292)	788	260		540	91 (87)	270 (—)	281			520	15	265	215	390	435					
ARH150S	150	1,695 (1,793)	205 (303)	980 (976)	238 (240)	540		82 (78)	—	294	570	15			270	260	370	447	13	4	13	22	—
ARH200S	200	1,668 (1,866)	274 (472)	1,100 (1,260)	370 (290)		540	100 (180)	450	560			700	15	406	254	511 (521)	566					

Model	Outlet dia (mm)	A	B	C	D	E	F	G	H	J	K	L	M	N	P	Q	R	S	T	U	V	W	Weight (kg)
ARH50SP	50	741 (841)	135 (235)	487 (479)	120 (124)	340	74 (70)	—	210	290	15	130	130	173	221	4	13	4	13	25	16	—	155 (53)
ARH65SP	65	809 (909)	137 (237)	556 (548)	125 (129)	400	78 (74)	—	212	330		15	175	125	202								228
ARH80SP	80	948 (1,047)	147 (246)	636 (628)	153 (157)	460	88 (84)	—	260	360	15		174	126	212	234	4	13	4	13	25	16	—
ARH100SP	5.5, 7.5kW	1,009 (1,108)	155 (254)	704 (696)	164 (168)	540	82 (78)	—	294			360	15	172	158	209							
	11kW	995 (1,094)	143 (242)	722 (714)	151 (155)		540	91 (87)	270 (—)	281	440			15	165	245	219	247	4	13	4	13	25

Notes:

- (1) The safety valve discharge outlet of ARH20S and 25S have Rc3/4 and G1 female thread respectively rather than flange.
- (2) Bolt hole diameter and pitch of the discharge flange comply with JIS B2239 : 10K flange.
- (3) For indoor use only. Consult us regarding outdoor applications.
- (4) Dimensions of the blower with the anti-vibration base are shown in parentheses. * The weight excludes the weight of the motor and motor base.
- (5) L-type inlet silencer specifications (option) for low ceilings are also available.
- (6) Dimensions are when Japanese-brand motor (previous IE1/IE2) is mounted.

Setup example

(L-type inlet silencer specifications)

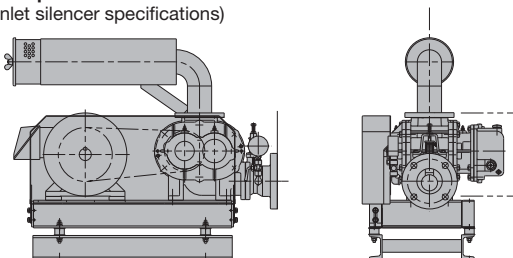

Performance Curve ARH-E

ARH20E

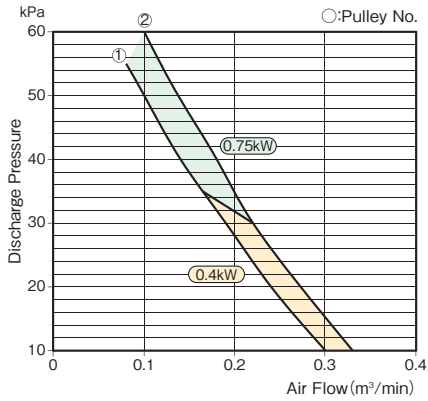

ARH25E

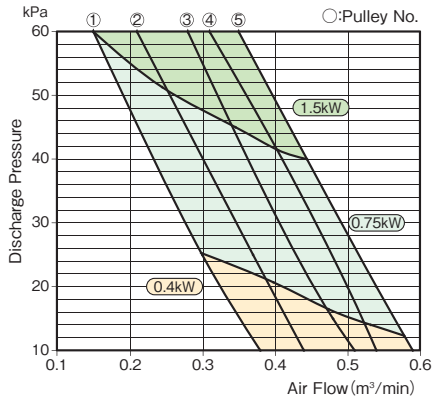

ARH32E

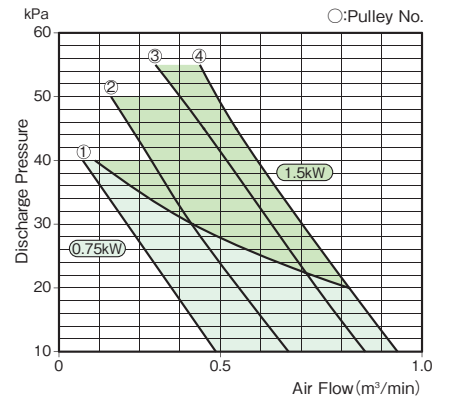

ARH40E

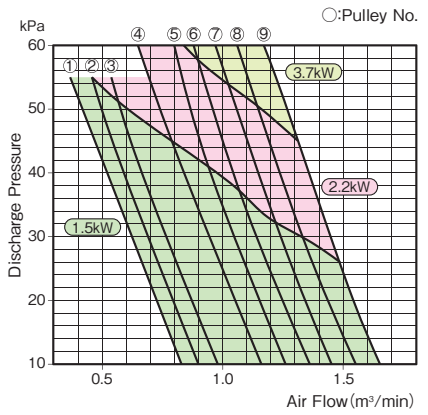

ARH50E

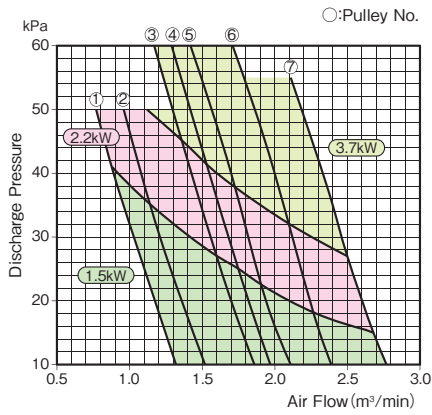

ARH65E

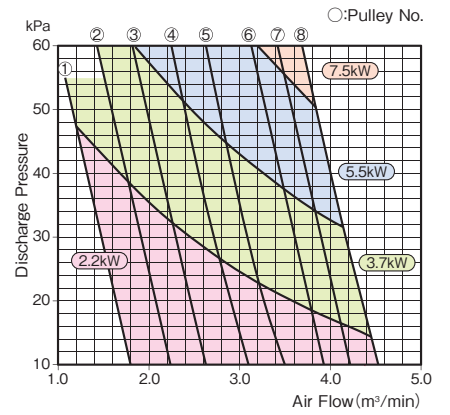

ARH80E

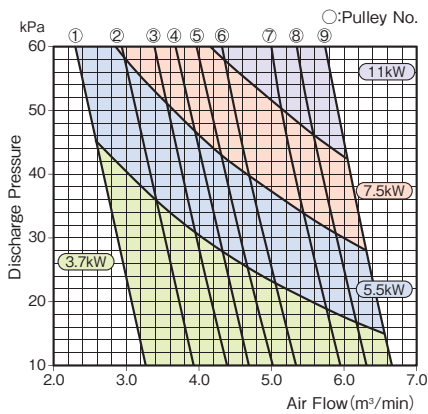

ARH100E

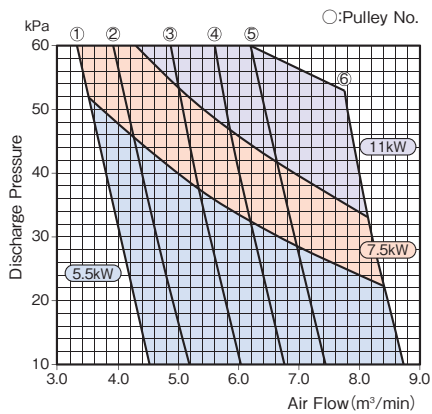

ARH125E

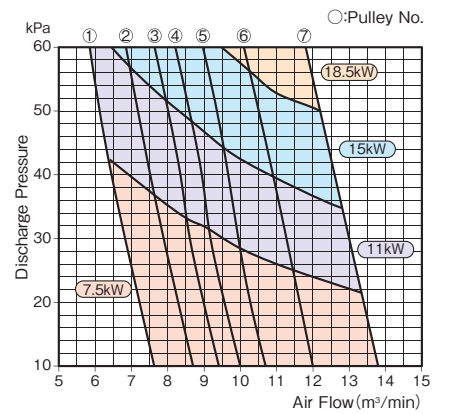

ARH125EA

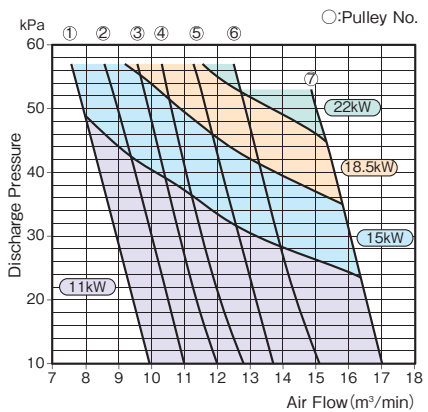

ARH125EF

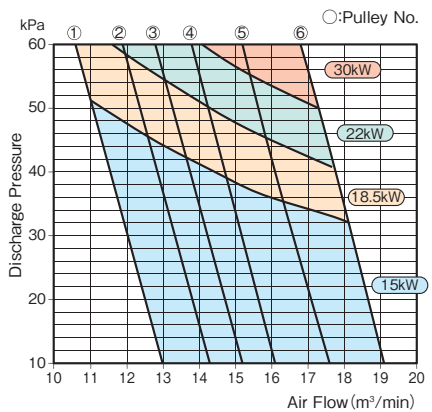

ARH150E

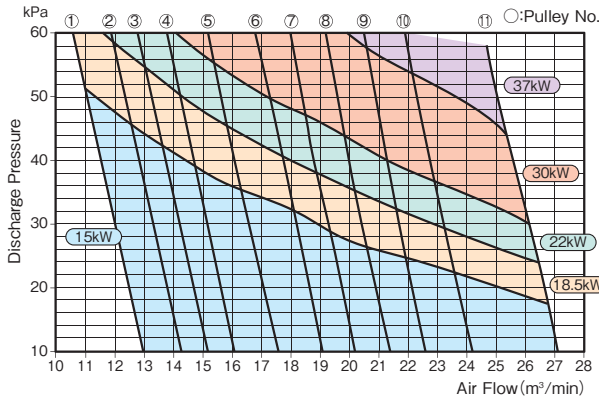

ARH200E

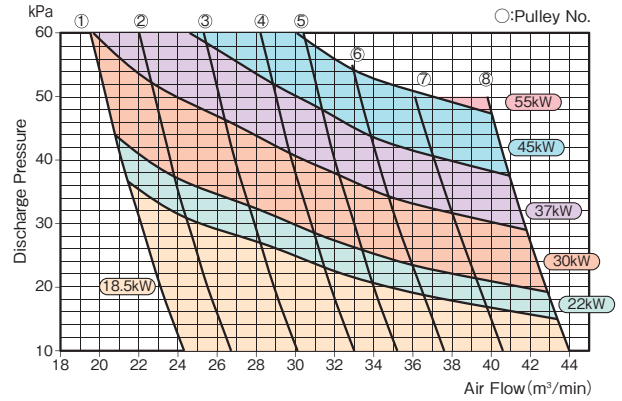

Performance Curve ARH-EP

ARH50EP

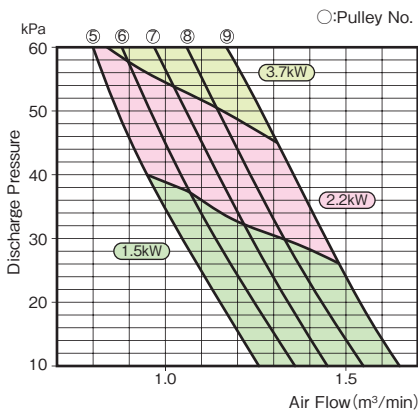

ARH65EP

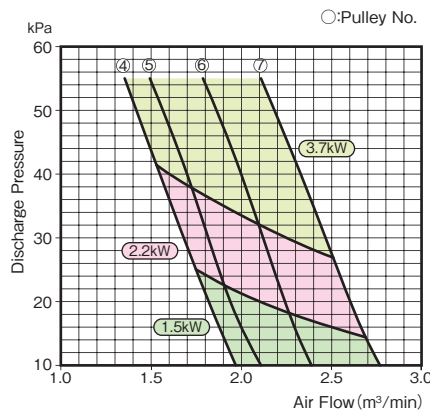

ARH80EP

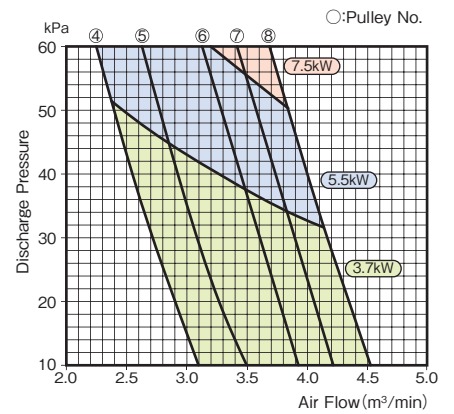

ARH100EP

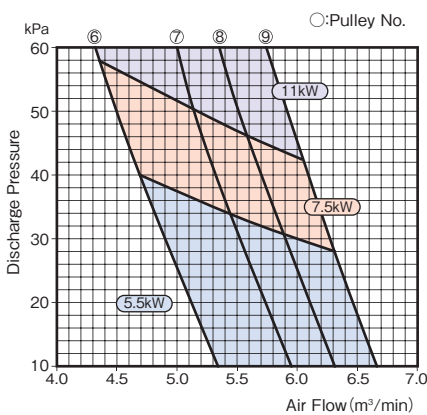

Notes:

- (1) The air flow rate indicates the volume of air on the suction side.
- (2) Air flow rate tolerance: $\pm 5\%$
- (3) Consult us for any requirements not included in the table.
- (4) For indoor use only. Consult us for outdoor applications.
- (5) Specifications are subject to change without notice.

Sound Levels

[dB(A)]

Model	Pulley No.	Rotor Speed (min ⁻¹)	Discharge Pressure (kPa)					
			10	20	30	40	50	60
ARH20E	1	1630	58	59	60	61	61	—
	2	1730	60	61	62	63	63	64
ARH25E	1	1940	62	63	63	64	64	65
	2	2180	63	64	65	66	66	67
	3	2440	64	65	66	67	67	68
	4	2580	65	66	67	68	68	69
	5	2730	66	67	68	69	69	70
ARH32E	1	1200	65	66	67	68	—	—
	2	1440	66	67	68	69	70	—
	3	1710	67	68	69	70	71	—
	4	1860	69	70	71	72	73	—
ARH40E	1	1680	66	67	68	69	70	—
	2	1820	67	68	70	71	72	—
	3	1920	69	70	71	71	72	—
	4	2200	70	71	71	71	72	73
	5	2370	70	71	71	71	72	74
	6	2520	70	71	71	72	72	74
	7	2690	71	72	72	73	73	75
	8	2840	71	72	72	73	74	75
	9	3020	71	72	72	73	74	75
ARH50E	1	1240	63	64	66	67	69	—
	2	1390	66	66	68	70	71	—
	3	1680	70	70	71	72	73	74
	4	1770	70	70	71	72	73	74
	5	1870	70	71	72	73	74	74
	6	2100	71	72	73	74	75	75
	7	2390	73	75	75	75	76	—
ARH65E	1	1140	66	67	68	68	69	—
	2	1350	66	67	69	70	71	72
	3	1550	66	67	69	70	72	73
	4	1770	67	69	70	72	74	74
	5	1980	68	70	71	72	74	75
	6	2250	69	71	72	73	74	76
	7	2400	71	72	73	74	75	76
	8	2540	73	74	75	76	76	77
ARH80E	1	1170	70	71	72	73	74	75
	2	1370	72	72	73	74	75	76
	3	1520	73	74	74	76	77	78
	4	1620	73	74	75	76	77	78
	5	1710	74	75	76	76	78	79
	6	1810	75	76	77	78	79	80
	7	2010	76	77	78	79	79	80
	8	2130	77	78	78	79	79	80
	9	2250	77	78	79	79	79	80
ARH100E	1	1000	71	72	73	74	75	76
	2	1110	72	73	74	75	76	77
	3	1280	73	74	75	77	77	79
	4	1420	75	75	76	78	79	80
	5	1550	76	77	78	79	80	80
	6	1820	77	78	79	80	81	—
ARH125E	1	1150	72	73	74	75	75	76
	2	1290	72	73	74	75	76	76
	3	1390	73	74	75	76	77	77
	4	1470	74	74	75	76	77	78
	5	1570	75	76	76	77	78	79
	6	1730	76	77	77	78	79	81
	7	1960	77	78	78	79	81	83
ARH125EA	1	1170	72	74	75	76	77	—
	2	1280	73	75	77	78	79	—
	3	1400	73	75	78	79	80	—
	4	1470	73	75	78	79	80	—
	5	1600	75	76	79	79	80	—
	6	1740	76	77	79	80	81	—
	7	1990	77	78	80	81	82	—
ARH125EF	1	980	72	73	74	75	77	78
	2	1060	72	73	74	75	77	78
	3	1120	73	74	75	76	78	79
	4	1180	74	75	76	78	79	80
	5	1290	75	76	77	79	80	81
	6	1390	76	77	78	80	81	82
	7	1480	77	78	80	81	82	83
	8	1570	77	79	81	82	83	84
	9	1650	79	80	81	82	83	84
	10	1770	81	82	83	84	85	86
	11	1980	84	85	86	86	87	88
ARH200E	1	1010	79	79	81	82	84	85
	2	1110	79	80	82	84	86	87
	3	1260	79	80	82	84	86	87
	4	1370	79	80	82	84	86	87
	5	1480	81	82	83	85	86	87
	6	1570	82	83	84	85	86	—
	7	1670	84	85	86	87	88	—
	8	1770	85	86	88	89	91	—

[dB(A)]

Model	Pulley No.	Rotor Speed (min ⁻¹)	Discharge Pressure (kPa)					
			10	20	30	40	50	60
ARH50EP	5	2370	70	71	71	71	72	74
	6	2520	70	71	71	72	72	74
	7	2690	71	72	72	73	73	75
	8	2840	71	72	72	73	74	75
	9	3020	71	72	72	73	74	75
ARH65EP	4	1770	70	70	71	72	73	74
	5	1870	70	71	72	73	74	75
	6	2100	71	72	73	74	75	75
ARH80EP	7	2390	73	75	75	75	76	—
	4	1770	67	69	70	72	74	74
	5	1980	68	70	71	72	74	75
	6	2250	69	71	72	73	74	76
ARH100EP	7	2400	71	72	73	74	75	76
	8	2540	73	74	75	76	76	77
	6	1810	75	76	77	78	79	80
	7	2010	76	77	78	79	79	80
	8	2130	77	78	78	79	79	80
	9	2250	77	78	79	79	79	80

- (1) Typical sound levels [±3dB(A)] are measured at a distance of one meter from the blower side. Provided for reference only.
- (2) Sound levels vary depending on the base (foundation) condition and piping configuration.
- (3) Blower Rotation Speed is for reference.

Sectional View

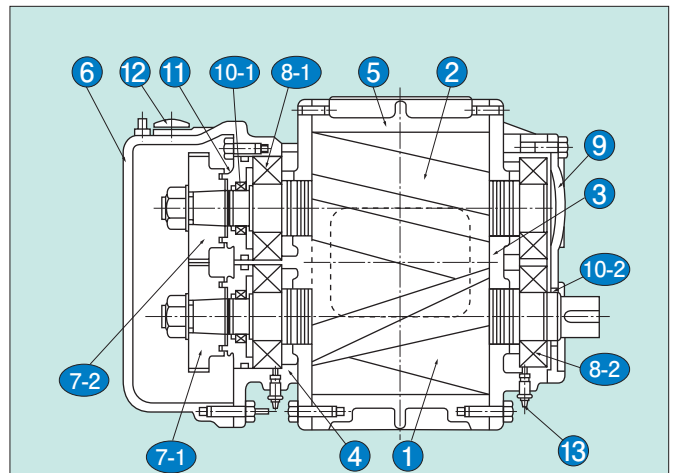

No.	Name	Material	No.	Name	Material
1	Rotor (driving)	FCD500	8-1	Ball bearing	—
2	Rotor (driven)	FCD500	8-2	Ball bearing	—
3	Bearing plate	FC200	9	Bearing cover	SS400/SPHC/SPCC
4	Bearing case	FC200	10-1	Oil seal	Fluoro rubber
5	Rotor housing	FC200	10-2	Oil seal	NBR
6	Gear case	FC200	11	Seal box	SS400
7-1	Timing gear	SCM415	12	Oil gauge	—
7-2	Timing gear	SCM415	13	Grease nipple	—

- Notes:
- (1) For Models ARH20E, ARH25E, ARH32E, ARH40E and ARH50EP, bearing plate No.3 and rotor housing No.5 are constructed as one piece.
 - (2) ARH125EF · 150E · 200E : Rotor is made of FC200 (helical portion) and S45C (shaft portion). ARH20E-125EA : Helical and shaft are manufactured of FCD500 in one piece parts.
 - (3) Use Shell Stamina Grease RL2 to replenish grease every three months.
 - (4) Completely replace gear oil with VG 220 gear oil every three months. (The blower is shipped with Shell Omara S2G 220.)
 - (5) Bearings of ARH20E-125E are special ones. Be sure to replace them with genuine ones upon overhaul. (Never use a commercialize bearings.)

Standard Motors (TEFC indoor type)

Model	Applicable Motor Output (kW)															
	0.4	0.75	1.5	2.2	3.7	5.5	7.5	11	15	18.5	22	30	37	45	55	
ARH20E	○	○														
ARH25E	○	○														
ARH32E		○														
ARH40E			○													
ARH50E				○												
ARH65E					○											
ARH80E						○										
ARH100E							○									
ARH125E								○								
ARH125EA									○							
ARH125EF										○						
ARH150E											○					
ARH200E												○				

Star-delta starting is available for motors 5.5kW and over.

Model	Applicable Motor Output (kW)					
	1.5	2.2	3.7	5.5	7.5	11
ARH50EP	○	○	○			
ARH65EP	○	○	○			
ARH80EP			○	○	○	
ARH100EP				○	○	○

Standard Accessories

- Common Base 1
- V-pulley, V-belt, Belt Cover 1
- Pressure Gauge (160 kPa, with gauge cock and R1/4 setscrew) 1
- Inlet Silencer (with filter) 1
- Safety Valve (with check valve) 1
- IP44-compliant TEFC Motor (indoor type) with base. 1

Dimensions

(mm)

Standard Dimensions

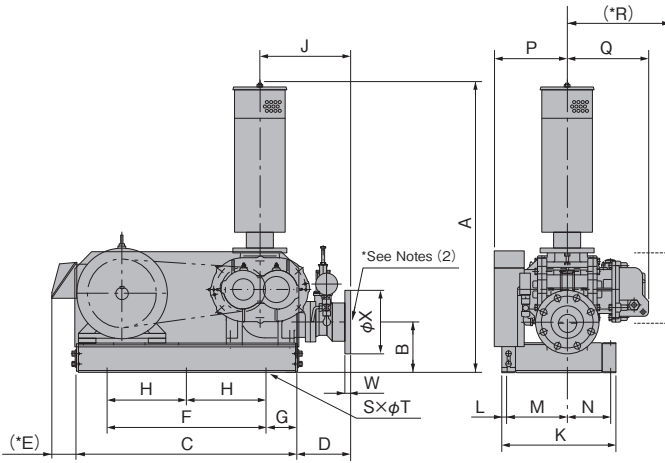

Dimensions with anti-vibration base

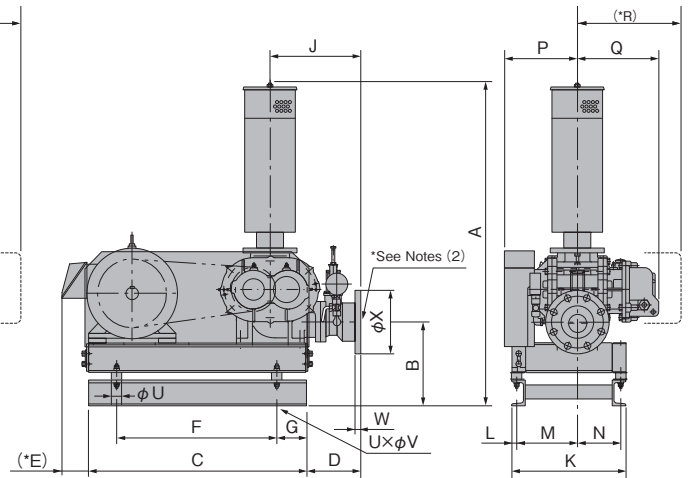

Model	Outlet dia (mm)	A	B	C	D	E	F	G	H	J	K	L	M	N	P	Q	R	S	T	U	V	W	X	Weight (kg)
ARH20E	20	456 (511)	133 (188)	430	53 (25)	69 (83)	350	25	-	256 (228)	300	13	110	164	124	156	175 (194)		12		12	-	-	22 (26)
ARH25E	25																							
ARH32E	32	761 (861)	135 (235)	487 (479)	125 (129)	24 (28)	340	74 (70)	-	215	290		130	130	173	221	-						135 (140)	45 (53)
ARH40E	40																229					20	155	70 (79)
ARH50E	50	828 (928)	137 (237)	556 (548)	120 (124)	44 (48)	400	78 (74)	-	207	330		175	125	202	228	-	4					175	100 (111)
ARH65E	65	967 (1,066)	147 (246)	636 (628)	138 (142)	93 (97)	460	88 (84)	-	245		15	174	126	212	234	293		13	4	13		185	140 (152)
ARH80E	3.7~7.5kW	1,029 (1,127)	155 (254)	704 (696)	164 (168)	99 (103)		82 (78)	-	294	360		172	158	209	247	291						210	170 (184)
	11kW	1,162 (1,115)	143 (242)	722 (714)	151 (155)	122 (126)	540	91 (87)	270	411	440		165	245	219	247	417						280 (295)	145 (160)
ARH100E	100	1,117 (1,216)	150 (249)		164 (168)	122 (126)				281			221	189	288	289	361						210	170 (184)
ARH125E	125	1,297 (1,396)	193 (292)	788 (780)	266 (270)	164 (168)	700	44 (40)	350	470			234	196	372	395	-						250	315 (332)
ARH125EA	125	1,324 (1,423)		788	260	217 (217)	710	40	355	520			265	215	390	435	-	6	14		14		280 (295)	580 (598)
ARH125EF	125	1,695 (1,793)	205 (303)	980 (976)	238 (240)	195 (197)	800	53 (51)	400	491	570		270	260	370	447	490			6			280 (295)	590 (608)
ARH150E	150			298 (300)		115 (119)				551			406	254	511 (521)	566	-					26	330	800 (895)
ARH200E	200	1,669 (1,867)	274 (472)	1,100 (1,250)	370 (290)	161 (81)	900	100 (180)	450	560	700		406	254	511 (521)	566	-		18.5		18.5		330	800 (895)

Model	Outlet dia (mm)	A	B	C	D	E	F	G	H	J	K	L	M	N	P	Q	R	S	T	U	V	W	X	Weight (kg)
ARH50EP	50	761 (861)	135 (235)	487 (479)	120 (124)	48 (52)	340	74 (70)	-	210	290		130	130	173	221	229						155	45 (53)
ARH65EP	65	828 (928)	137 (237)	556 (548)	125 (129)	44 (48)	400	78 (74)	-	212	330		175	125	202	228	-	4					175	70 (79)
ARH80EP	80	967 (1,066)	147 (246)	636 (628)	153 (157)	93 (97)	460	88 (84)	-	260		15	174	126	212	234	293		13	4	13		185	100 (111)
ARH100EP	5.5, 7.5kW	1,029 (1,127)	155 (254)	704 (696)	164 (168)	99 (103)		82 (78)	-	294	360		172	158	209	247	291						210	140 (152)
	11kW	1,017 (1,115)	143 (242)	722 (714)	151 (155)	122 (126)	540	91 (87)	270	440			165	245	219	247	417	6					210	145 (160)

Notes:

- (1) The ARH20E/25E safety valve discharge outlet is a tubular parallel female thread rather than a flange.
- (2) Bolt hole diameter and pitch of the discharge flange comply with JIS B2239 : 10K flange.
- (3) This standard motor is Japanese-brand totally enclosed fan cooled motor (indoor type IP44). Use of a special motor or non-Japanese brand may require a different base size.
- (4) For indoor use only. Consult us regarding outdoor applications.
- (5) Dimensions of the blower with the anti-vibration base are shown in parentheses. * The weight excludes the weight of the motor and motor base.
- (6) *E and *R dimensions are the maximum dimensions when equipped with the largest size of standard motor.
- (7) L-type inlet silencer specifications (option) for low ceilings are also available.

Setup example

(L-type inlet silencer specifications)

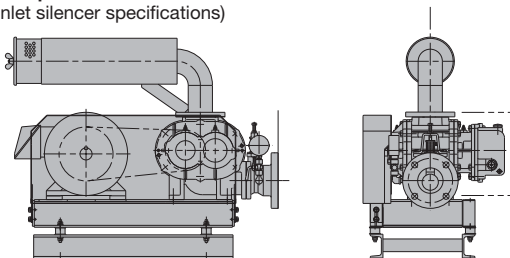

Optional Accessories

● Outlet Silencer

●Type A Outlet Silencer

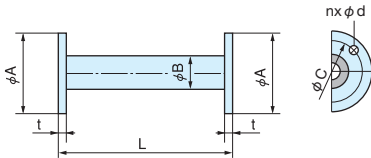
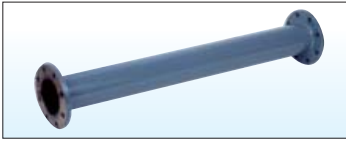

Nominal Diameter(mm)	L	A	B	C	n	d	t	Weight (kg)	
20	380	100	43	75	4	15	14	2.5	
25		125		90			4.0		
32	450	135	100	4.5					
40		140	105	4.8					
50	560	155	61	120		19	16	6.5	
65	610	175	76	140				9.0	
80	770	185	89	150		8	23	18	11
100	1,060	210	114	175				18	
125	1,160	250	140	210	8	20	18	27	

- Use the blower under discharge pressure less than 60 kPa.
- Outer diameter, hole pitch and hole diameter of discharge flange comply with JIS B2239 : 10K flange.
- Material--- Standard : Steel
Option : Stainless Steel

●Type B Outlet Silencer

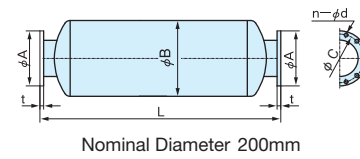
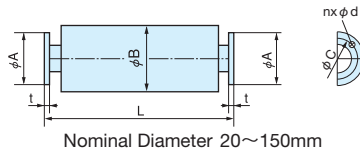
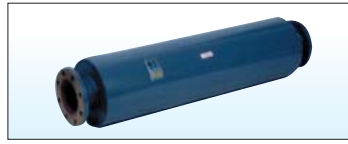

Nominal Diameter(mm)	L	A	B	C	n	d	t	Weight (kg)	
20	380	100	102	75	4	15	14	4.6	
25		125		90			5.6		
32	450	135	100	8.1					
40		140	105	8.4					
50	560	155	120	19		16	11	15	
65	610	175	140				15		
80	770	185	170	140		8	23	18	22
100	1,060	210	250	175				39	
125	1,160	250	290	210	20	59	20	59	
150	1,110	280	350	240			69		
200	1,440	330	462	290	12	22	95	95	

- Outer diameter, hole pitch and hole diameter of discharge flange comply with JIS B2239 : 10K flange.

●Flexible joint

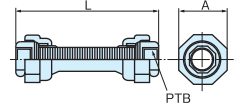
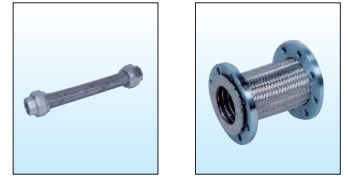

Nominal Diameter 20-25 mm

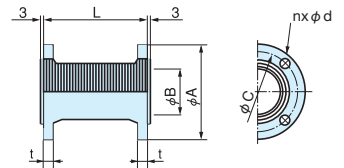

Nominal Diameter 32~200mm

Nominal Diameter(mm)	L	A	B	C	n	d	t	Weight (kg)	
20	300	47	Rc ^{3/4}	—	—	—	—	1	
25		56	Rc1	—	—	—	—	—	
32	300	135	41	100	4	19	16	4	
40		140	46	105				5	
50	155	54	120	16					
65	175	67	140	18					
80	230	185	79	150		8	23	20	6
100		210	104	175				8	
125	300	250	129	210		23	22	20	12
150		280	152	240				15	
200	330	203	290	12	22	18	18		

- Consult us for a nominal diameter of 250.
- Outer diameter, hole pitch and hole diameter of discharge flange comply with JIS B2239 : 10K flange.

●Other Options

Motor

- Totally enclosed fan-cooled outdoor type
- Tropical climate specification

Belt Cover

- V-belt inspection window

Rubber Vibration Isolator

Gate Valve

Vertical Outlet Silencer

Pressure Gauge

- Pressure gauge stand

Packing Size

■ ARH-S / ARH-E

Model	Length L	Width W	Height H
ARH20S / 20E ARH25S / 25E	520	460	300
ARH32S / 32E ARH40S / 40E	750	530	800
ARH50S / 50E ARH65S / 65E	850	610	820
ARH80S / 80E	990	630	890
ARH80S / 80E	3.7~7.5kW	1,080	700
	11kW	1,200	790
ARH100S / 100E	1,200	790	1,000
ARH125S / 125E	1,280	910	1,150
ARH125SA / 125EA	1,280	970	1,150
ARH125SF / 125EF	1,520	960	1,310
ARH150S / 150E	1,520	960	1,310
ARH200S / 200E	1,780	1,230	1,300

■ ARH-SP / ARH-EP

Model	Length L	Width W	Height H
ARH50SP / 50EP	750	530	800
ARH65SP / 65EP	850	610	820
ARH80SP / 80EP	990	630	890
ARH100SP / 100EP	3.7~7.5kW	1,080	700
	11kW	1,200	790

Selecting a VFD-Controlled Model

VFD control is available for all models. This feature allows precise control of the air flow rate to accommodate water treatment volumes that vary over season and time.

Operation at excessively slow speeds with the VFD may allow high-temperature compressed air to leak into the suction side through Clearance (1) between rotors and Clearance (2) between rotors and housing wall, as illustrated below. This may result in a temperature rise that exceeds the bearing temperature limit, resulting in a blower failure.

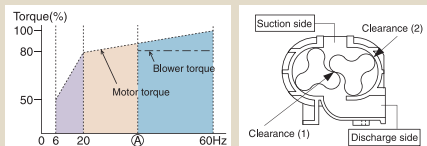

Notes: (A) indicates the lower limit of the frequency control range based on the blower temperature rise.

- 1) Blower torque remains constant when the motor speed is reduced because of the blower's constant-torque characteristic.
- 2) When selecting a VFD, ensure the rated output of the VFD is equal to or greater than the rated output of the motor.
- 3) The control range of the VFD starts at 60 Hz regardless of the frequency of the power source. The control range depends on several factors including the application, motor output, and model.

Combination 1 General-purpose motor and VFD (V/F control)

Blower application (a) (Fig. 1)
The blower is usable within the frequency range from (A) to 60 Hz because the blower torque is less than the motor torque. The blower is not usable if the frequency falls below (A) because the blower temperature will rise.

Blower application (b) (Fig. 2)
The blower torque exceeds the motor torque when the frequency is below (B). The blower is usable within the frequency range from (B) to 60 Hz.

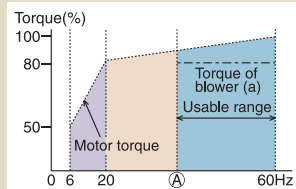

Figure 1 Blower(a) Frequency(Hz)

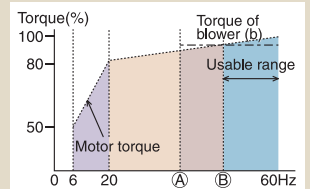

Figure 2 Blower (b) Frequency(Hz)

Combination 2 General-purpose motor and VFD (Vector control)

Both blowers (a) and (b) are usable within the range from (A) to 60 Hz. The blowers are not usable below (A) because the blower temperature will rise.

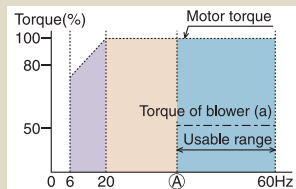

Figure 3 Blower(a) Frequency(Hz)

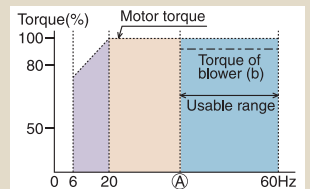

Figure 4 Blower (b) Frequency(Hz)

Consult us if you require VFD control. We can provide an VFD calculation sheet.

Differences between ARH-E type equipped with IE3 motor and type equipped with IE1 motor (Points to note if replacing your previous model with the IE3 motor)

Significant differences in motor size and weight

- Motor outer dimensions: The frame size of IE3 motor does not differ from the IE1 motor, so it can be installed to the blower with IE1 motor. However, with the IE3 motor, the diameter and length of motor both tend to be larger. Because of this, the outer dimensions will be larger for some models, and so check the matching dimensions for cables, etc. and make sure that there is no interference with surrounding equipment during installation.
- Motor weight: As mentioned above, the motor size is larger, and so the weight of the motor has also increased as a result. (However, there is no need to reselect the anti vibration rubbers for ShinMaywa helical blowers as a result of this weight increase.)

Starting current increased

- With the IE3 motor, the starting current tends to be larger. As a result of this, it will be necessary to inspect equipment such as circuit protector to make sure they are appropriate. In addition, it is also possible that the capacity of the electromagnetic switch may need to be changed when replacing the motor.

Increase in rated operating speed of motors

- With the IE3 motor, the rated operating speed will increase. When replacing an IE1 motor with an IE3 motor, the air volume and output power increase as a result of the increased operating speed. Customers using the motor at around the maximum rated current (95% or more of the rated current), and looking into replacing their motors should notify ShinMaywa, as there is a possibility that excessive power may be generated as a result of the increased air volume.

Comparison of starting current values between ShinMaywa typical IE1 and IE3 motors

5.5kW (50Hz/60Hz)	150/131 ➔ 203/167
7.5kW (50Hz/60Hz)	206/180 ➔ 261/217

* For details, contact to your dealer or ShinMaywa.

Application example

• Examples of use

[MODELS USED]

ARH125S x 3 units

Used for aeration at sewage treatment plant



Water treatment

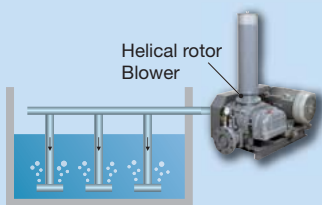

Used for water purification and for stirring precipitates at water treatment plants.

Transport of granules

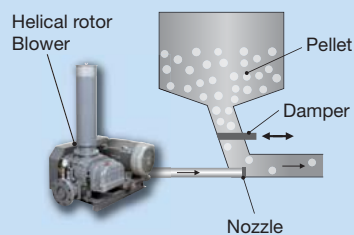

Used for pneumatic transport of pelletized raw materials such as vinyl chloride and polyethylene. (Suction type is also available)

Oxygenation of aquaculture ponds

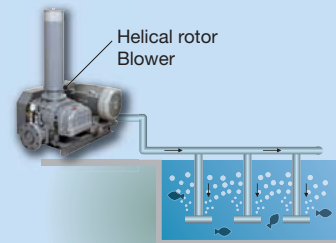

Used for oxygenation and stirring of the water in aquaculture ponds for various types of fish and shellfish. They are also used for aquariums and fish tanks.

A Variety of Uses

● Water treatment

- Aeration at sewage treatment plants
- Aeration of purifying tanks in condominiums, etc.
- Aeration of wastewater from food processing plants
- Aeration of wastewater from livestock farms

● Cultivation

- Oxygen supply in aquariums, culture ponds, etc.

● Pneumatic transportation

- Transportation of cement powder, etc.
- Transportation of wheat, soybeans, etc.
- Transfer of dust
- Collection of dust

● Other

- Foaming of water in baths and swimming pools.

Specifications and dimensions are subject to change without notice.

ShinMaywa Industries, Ltd.

International Business Group
Sales & Marketing Dept., Fluid Div.

3-2-43, Shitte, Tsurumi-ku, Yokohama, 230-0003, Japan
Phone : +81-45-584-1322 Fax : +81-45-575-2286
E-mail : sales.eisui@shinmaywa.co.jp

ShinMaywa (America), Ltd.

10737 Gateway West, Suite 240,
El Paso, Texas 79935, U.S.A.
Phone : +1-915-594-9862
Fax : +1-915-594-9866
E-mail : info@shinmaywaamerica.com

ShinMaywa (Asia) Pte. Ltd.

8 Burn Road, #14-10 Trivex,
Singapore 369977
Phone : +65-6224-0728
Fax : +65-6224-9678
E-mail : asia.ad@shinmaywa.com.sg

ShinMaywa (Shanghai) Trading Co., Ltd.

201107 Building 6, Lane 333, Zhujian Road,
Minhang District, Shanghai, China
Phone : +86-21-5296-2966
Fax : +86-21-5296-2970
E-mail : shanghai@shinmaywa.co.jp



ShinMaywa ONO PLANT

ISO 9001(No.956445)/ISO 14001(No.771888)